

图尔精密制造
ACCESSORIES COMPANY

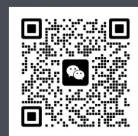
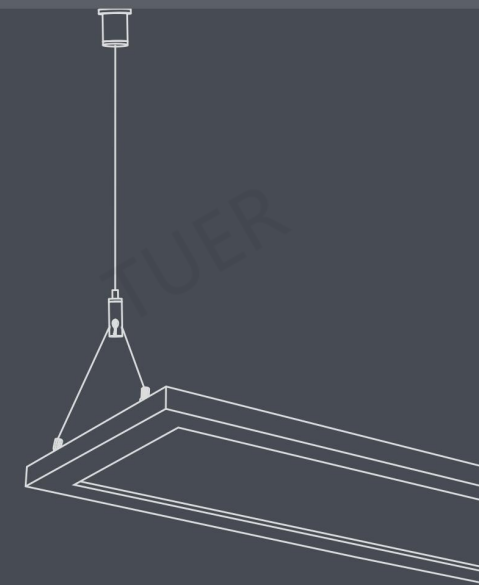

中山市图尔精密制造有限公司

ZHONGSHAN TUER PRECISION MANUFACTURING CO.,LTD

ADD : NO.158 LE'AN ROAD,LIANFENG,XIAOLAN TOWN,ZHONGSHAN, GUANGDONG, CHINA
TEL/WeChat/WhatsApp : +86 18925344891 / +86 18925349615
E-mail : julian@zstuer.com
Website : <https://www.zstuer.com>
Postal Code : 528415

中山市图尔精密制造有限公司
ZHONGSHAN TUER PRECISION MANUFACTURING CO.,LTD



Company profile

TUER is a professional manufacturer of lighting, building materials and sports equipment hardware accessories, Hanging System for Acoustic Panels and Billboard.

Our products range includes CNC hardware, Cable Grippers, Looping Maker, Ceiling Attachments, Hooks, Standoff, Steel Wire, Swivels joint, Rocker Arm and Suspension Kits.

The factory is located in Xiaolan Town, ZhongShan, Guangdong, China, with 2,500 Square Meters production area and advanced manufacturing equipment, including CNC high precision automatic lathes, Table Lathes, Grinder and Polishing Machines, Automatic Polishers and Spray Equipment, as well as Die Casting Machine and Testing Machine.

With the experience of manufacture and sales for more than 10 years, TUER is growing up steadily and rapidly. We have passed ISO9001 quality management system certification. Our well-equipped facilities, excellent quality control, on-time delivery and good after sales service enable us to guarantee total customer satisfaction and expand the global sales net work.

We are currently exporting our products mainly to USA, Canada, Japan, Korea, Russia, UK, France, Italy, Germany, Finland, Spain, Poland and other European Area. With the growing demand from end users for reduced installation cost and increased flexibility, suspension kit and hanging system is becoming more and more important.

Our product tenet is: easy to use and hard to defeat, give you easy and flexible installation solutions! Cooperate with TUER, make the installation easy and flexible!

公司简介

中山市图尔精密制造有限公司是一家专业生产灯饰、建材、运动器材五金配件、隔音板及广告牌悬挂系统的企业。

我们的产品范围包括CNC五金车件、锁线器、天花板附件、挂钩、广告吊码、万向头、摇臂、钢丝绳和悬挂套件。

工厂位于中国广东省中山市小榄镇，拥有2500平方米的生产面积和先进的生产设备，包括数控高精度自动车床、台式车床、磨床和抛光机、自动抛光机和喷涂设备、压铸机和拉力测试机、盐雾测试机等测试设备。经过十多年的生产和销售经验，图尔正稳步快速成长。我们通过了质量管理体系认证，完善的质量监控、守时的交期以及满意的售后服务，得到了国内客户认可的同时也拓展了全球销售网络。

我们目前主要出口到美国、加拿大、日本、韩国、俄罗斯、英国、法国、意大利、德国、芬兰、西班牙、波兰和其他欧洲地区。

随着终端用户对降低安装成本和增加灵活性的需求不断增长，悬挂套件和悬挂系统变得越来越重要。我们的产品宗旨是：产品易用难破，给您容易和灵活的安装解决方案！与TUER合作，使安装更容易，更灵活！



Certificate 证书





Contents

目录

Applications

Electrical/Pipework/HVAC page 01-02
电力应用/管道应用/暖通空调应用

Lighting page 03-04
灯饰应用

Signage/painted corridor page 05-06
标识系统应用/画廊应用

Acoustics page 07-08
隔音板应用

Products

Cable Gripper page 09-14
锁线器

Ceiling Attachment page 15-16
天花件

Hanger/Adaptors Attachment page 17-22
吊件/连接件

Coil spring lanyard/Jump Ropes page 22
工具绳子/运动跳绳

Suspension Kits page 23-27
吊线组合

Machine Parts page 28
五金车件

Swivel Joint page 29-30
万向头

Electric wire page 31-32
电线

Wire rope page 33
钢丝绳

Die-casting end stopper page 34
钢丝绳锌头规格表

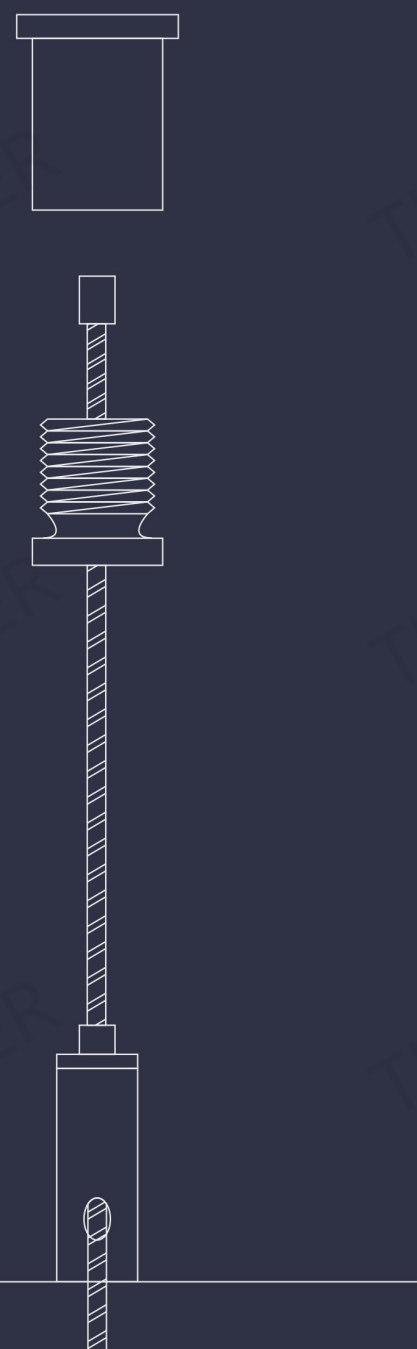

Suspension kits & Wire rope holders

zstuer.com[®]



Electrical/Pipework/HVAC

电力应用/管道应用/暖通空调应用

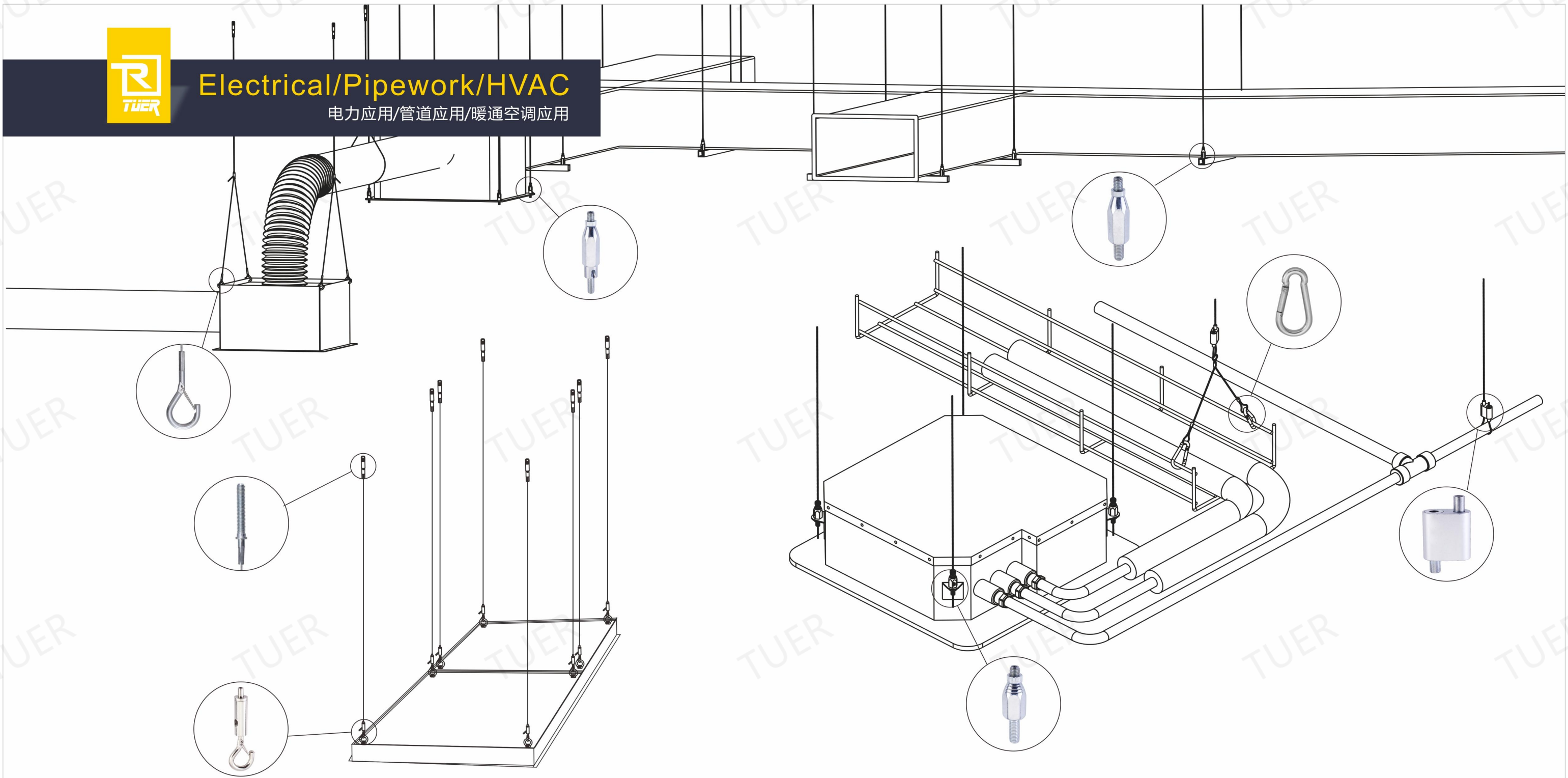

- Expertise, product take-off from plan.
- Can provide drawings.
- From ceiling to fixture, we can provide complete hanging systems for quick and easy labor-saving installation. we are your one-stop-shop.
- No pre-work, such as cutting or filing is required.
- Save time, labour and reduce costs by making the installation quicker and easier.

Has a wide range of feet available to suit your application.





Lighting

灯饰应用

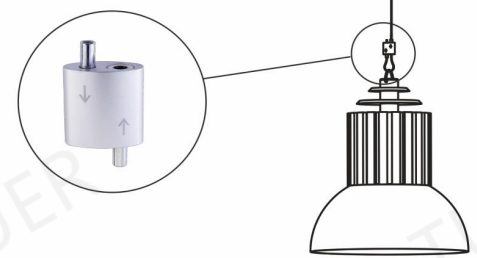
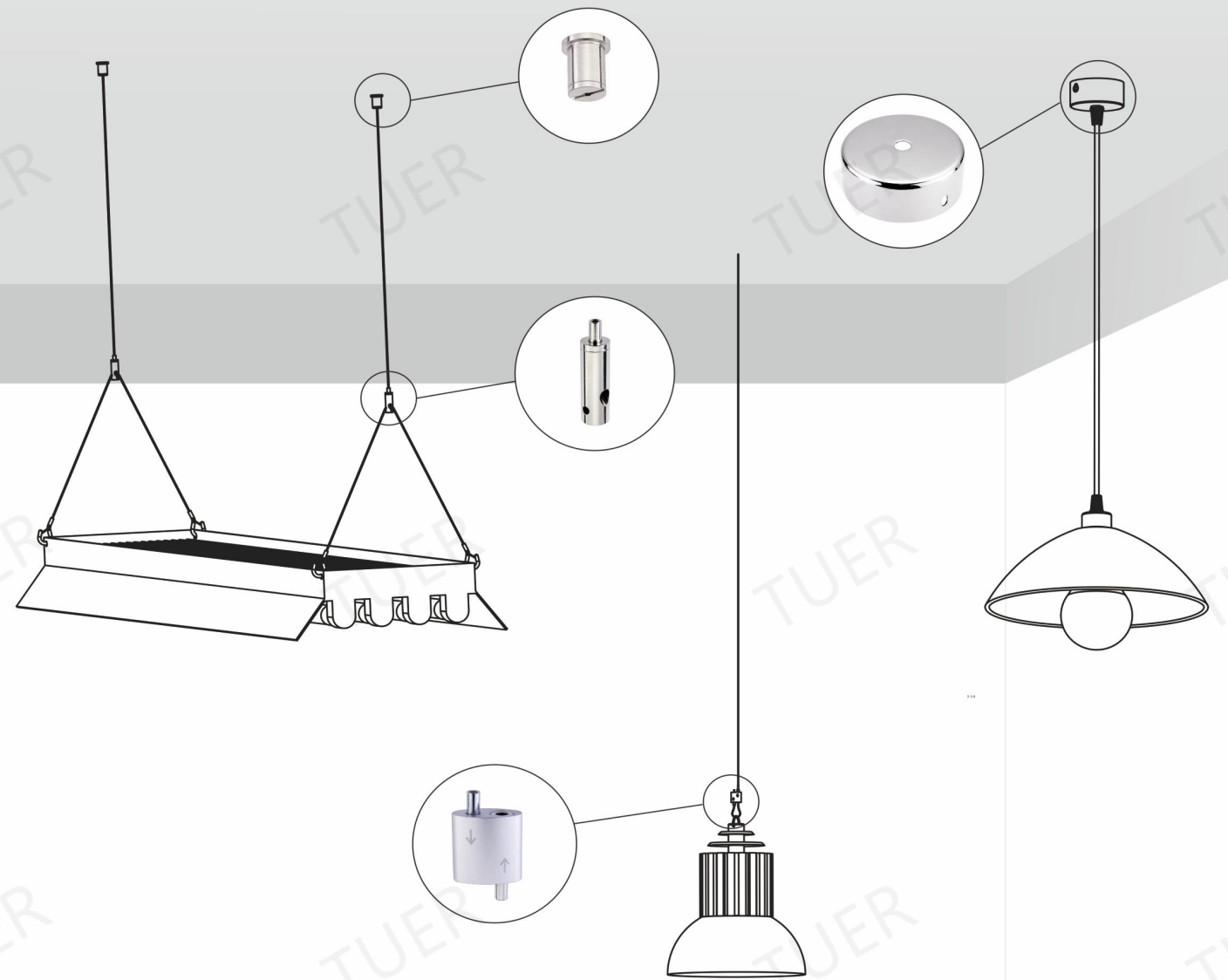
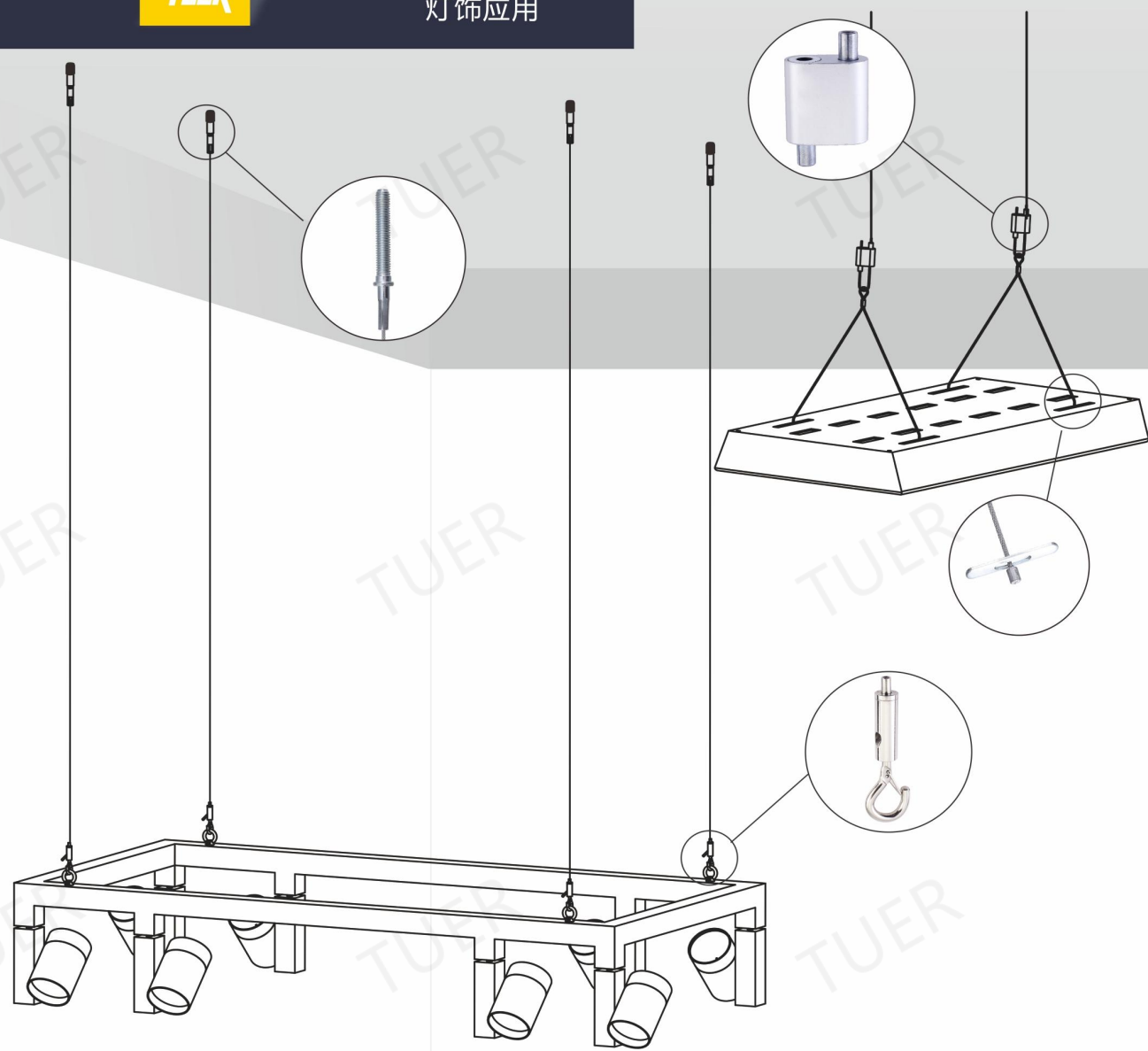

- Expertise, product take-off from plan.
- Can provide drawings.
- From ceiling to fixture, we can provide complete hanging systems for quick and easy labor-saving installation. we are your one-stop-shop.
- No pre-work, such as cutting or filing is required.
- Save time, labour and reduce costs by making the installation quicker and easier.

Has a wide range of feet available to suit your application.





Signage/painted corridor

标识系统应用/画廊应用

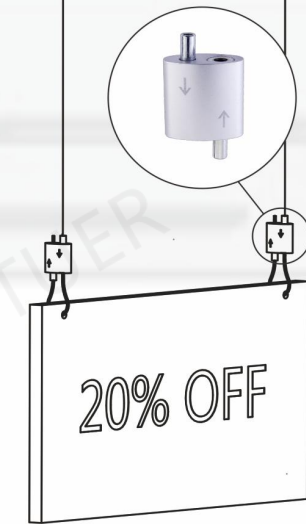
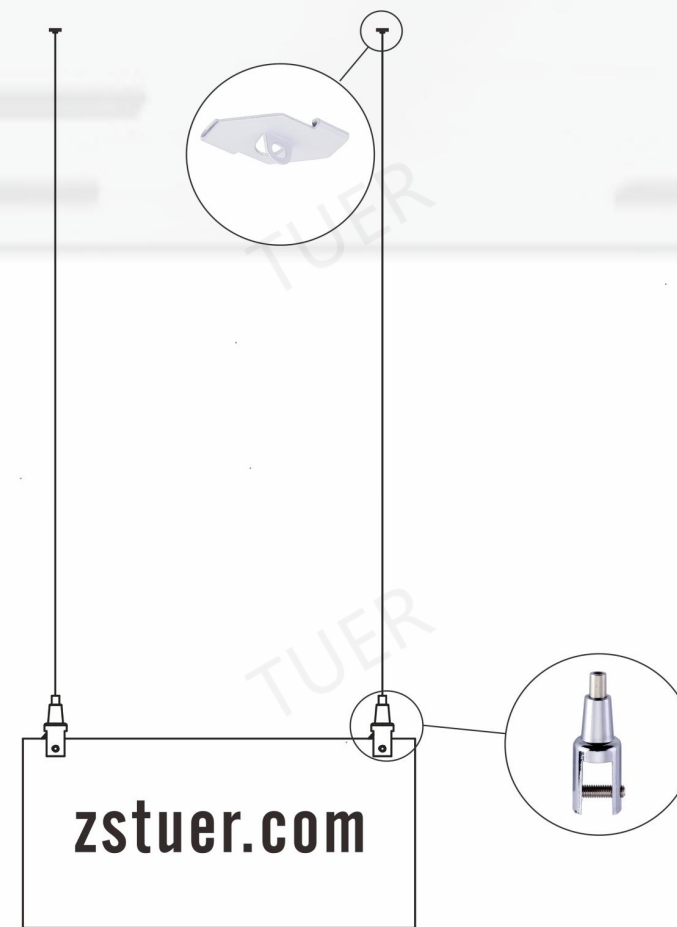
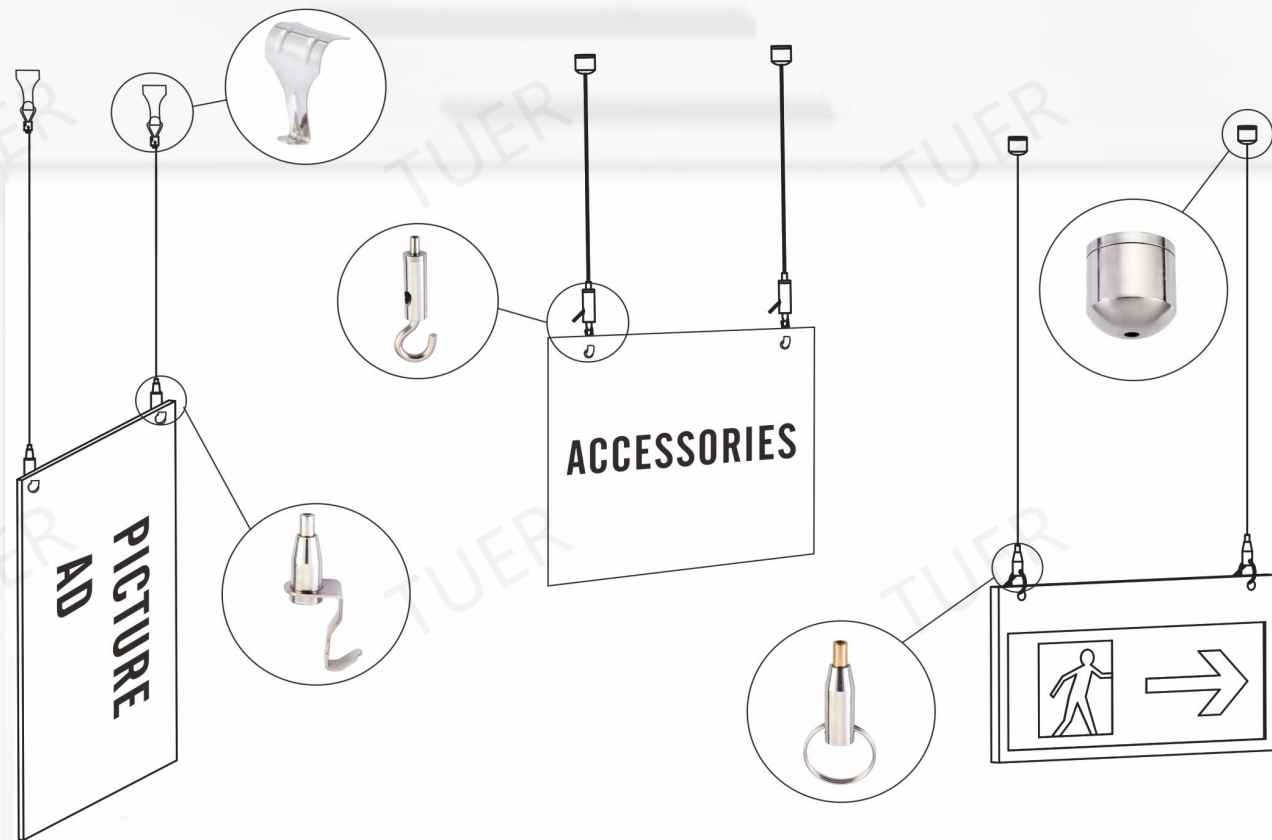

- Expertise, product take-off from plan.
- Can provide drawings.
- From ceiling to fixture, we can provide complete hanging systems for quick and easy labor-saving installation. we are your one-stop-shop.
- No pre-work, such as cutting or filing is required.
- Save time, labour and reduce costs by making the installation quicker and easier.

Has a wide range of feet available to suit your application.

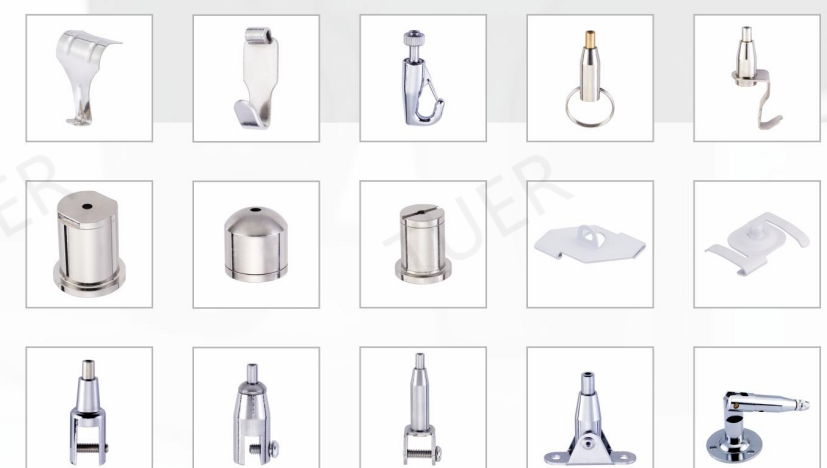



Acoustics

隔音板应用

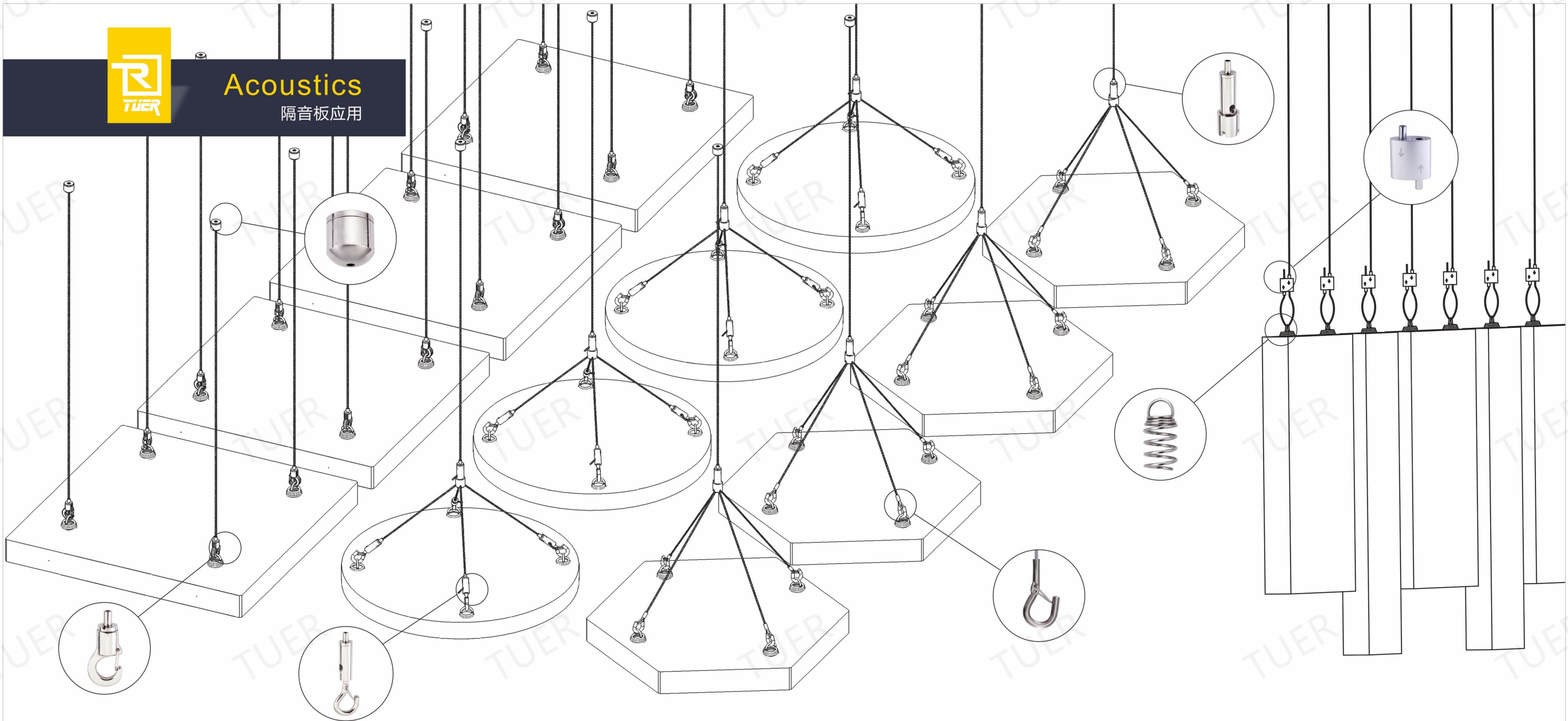

- Expertise, product take-off from plan.
- Can provide drawings.
- From ceiling to fixture, we can provide complete hanging systems for quick and easy labor-saving installation. we are your one-stop-shop.
- No pre-work, such as cutting or filing is required.
- Save time, labour and reduce costs by making the installation quicker and easier.

Has a wide range of feet available to suit your application.



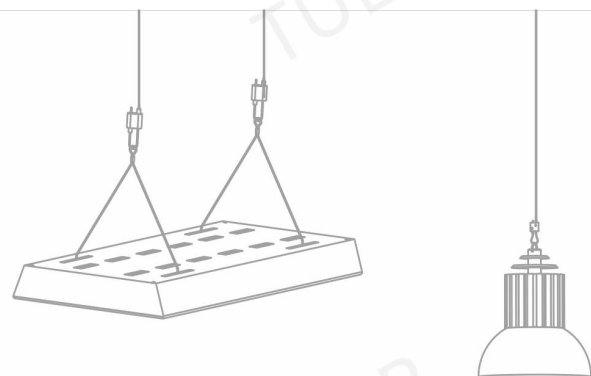

CABLE GRIPPER

锁线器

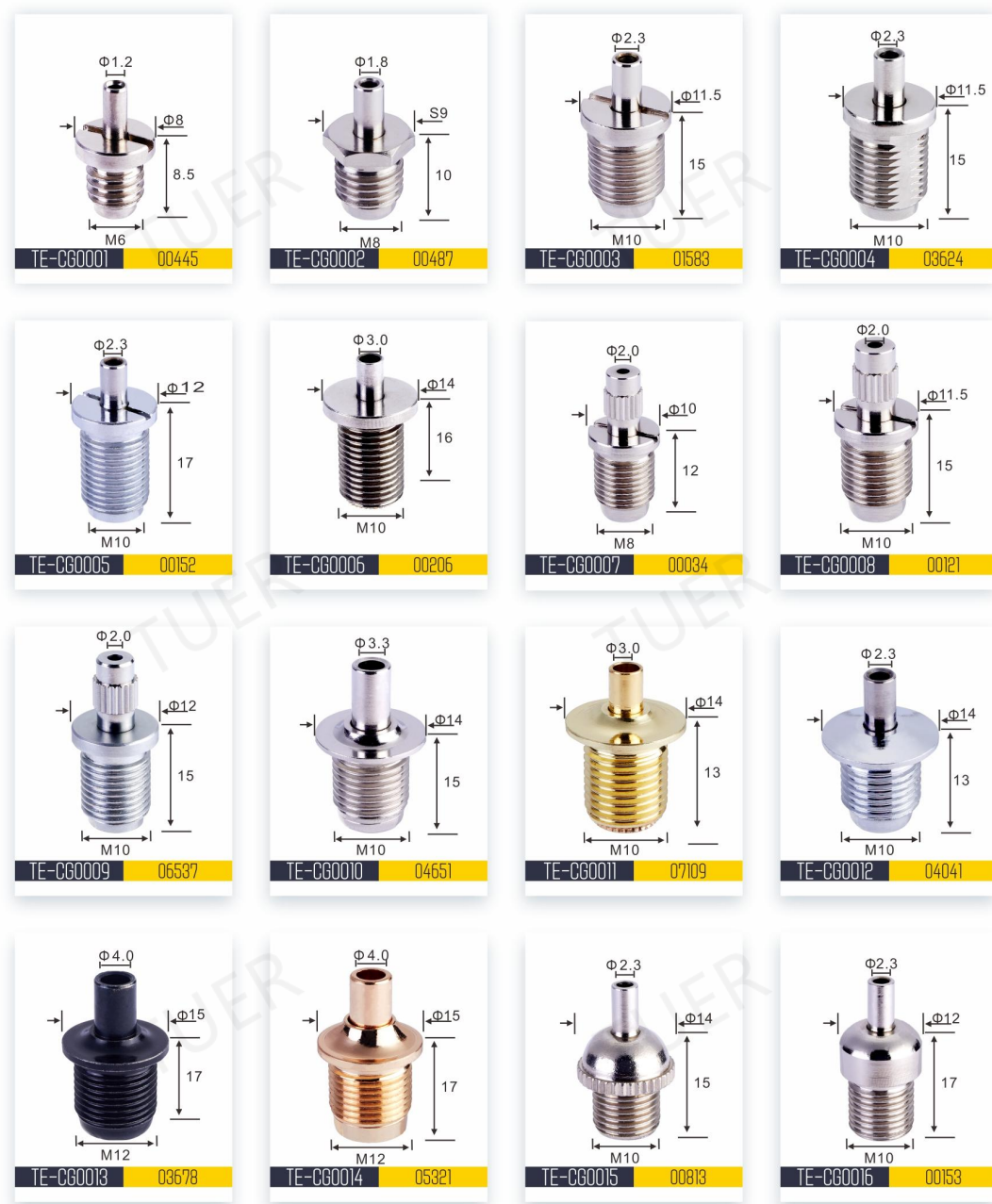

CABLE GRIPPER

锁线器

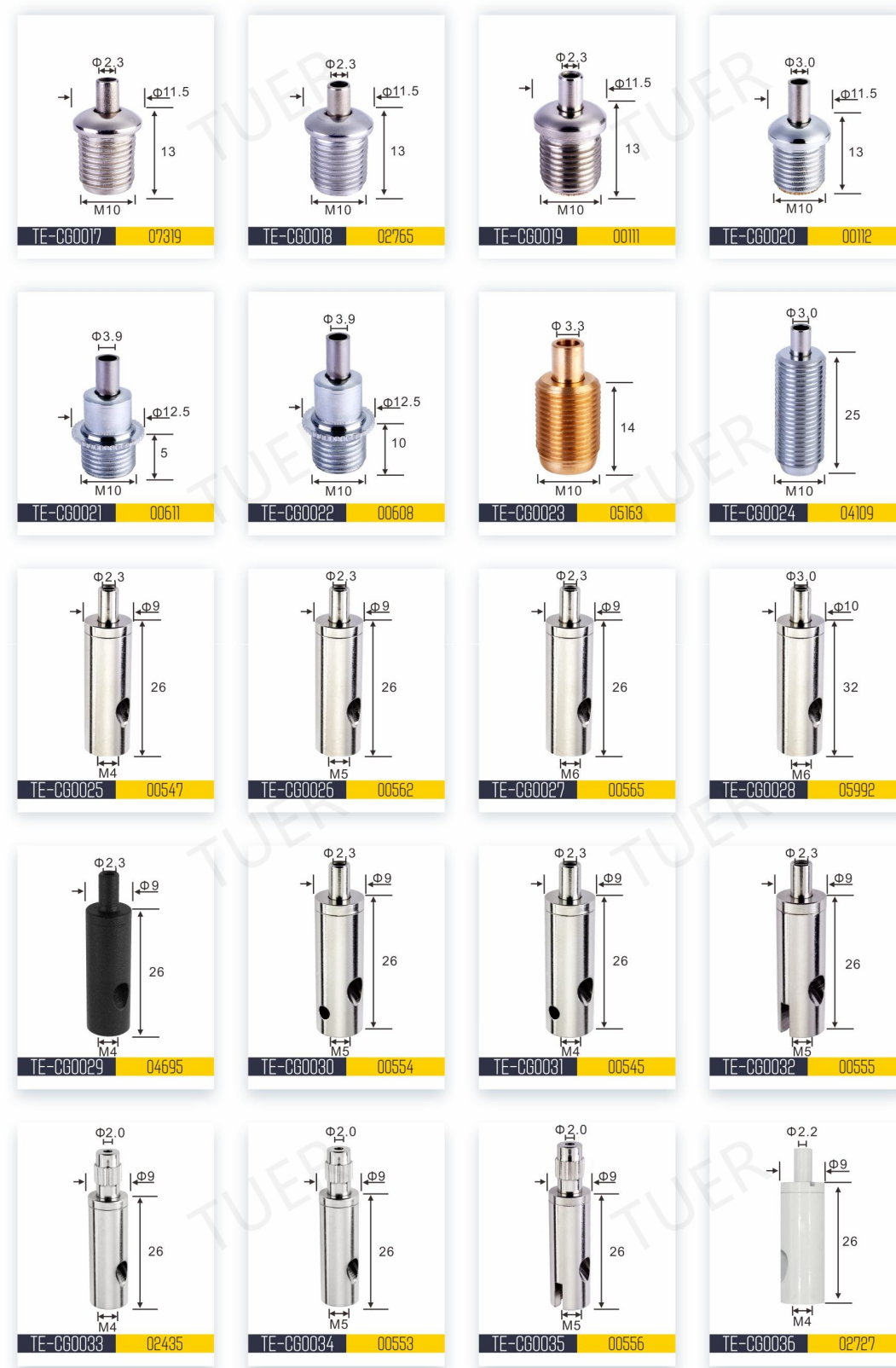



CABLE GRIPPER

锁线器



CABLE GRIPPER

锁线器

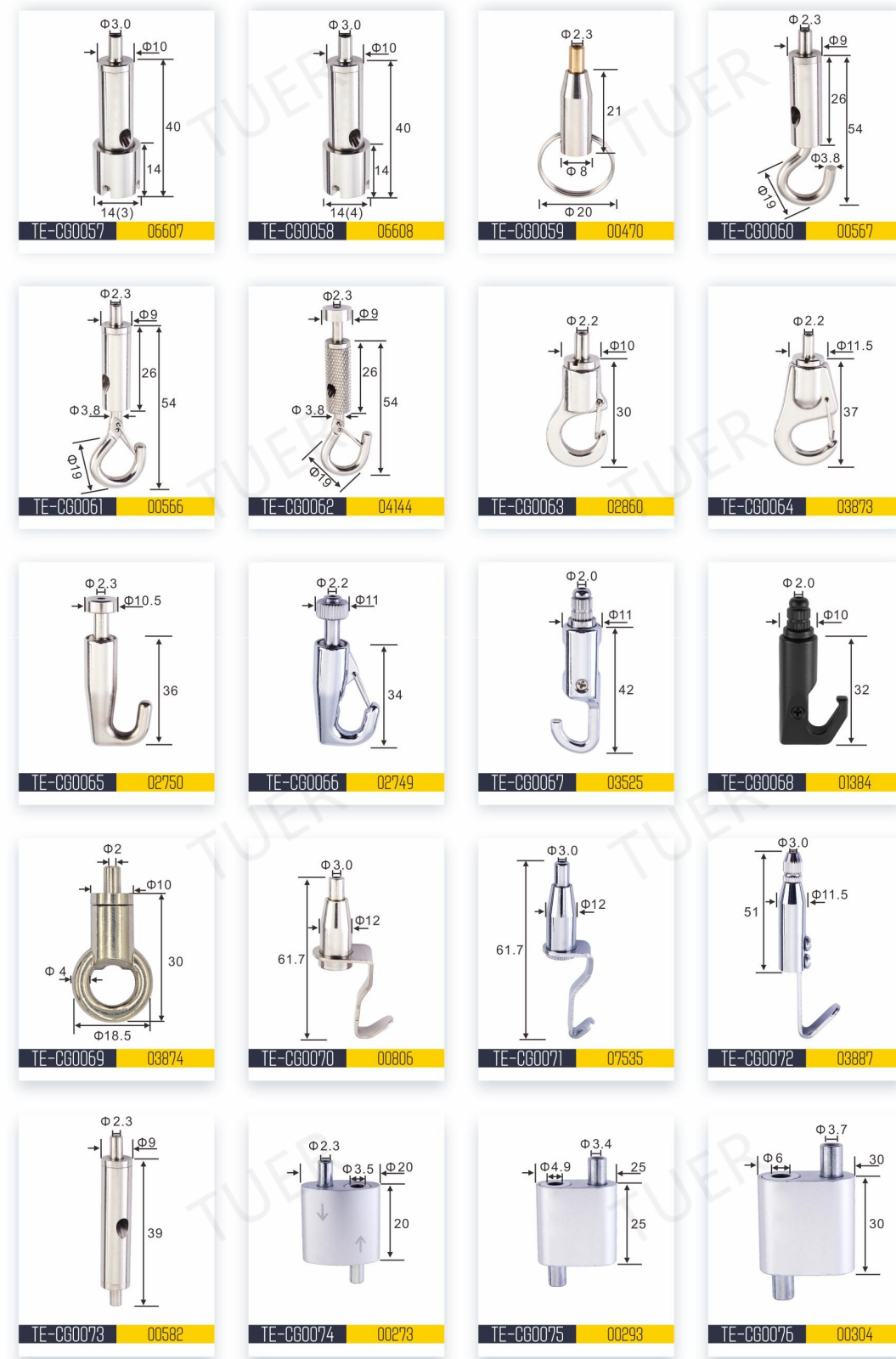



CABLE GRIPPER

锁线器

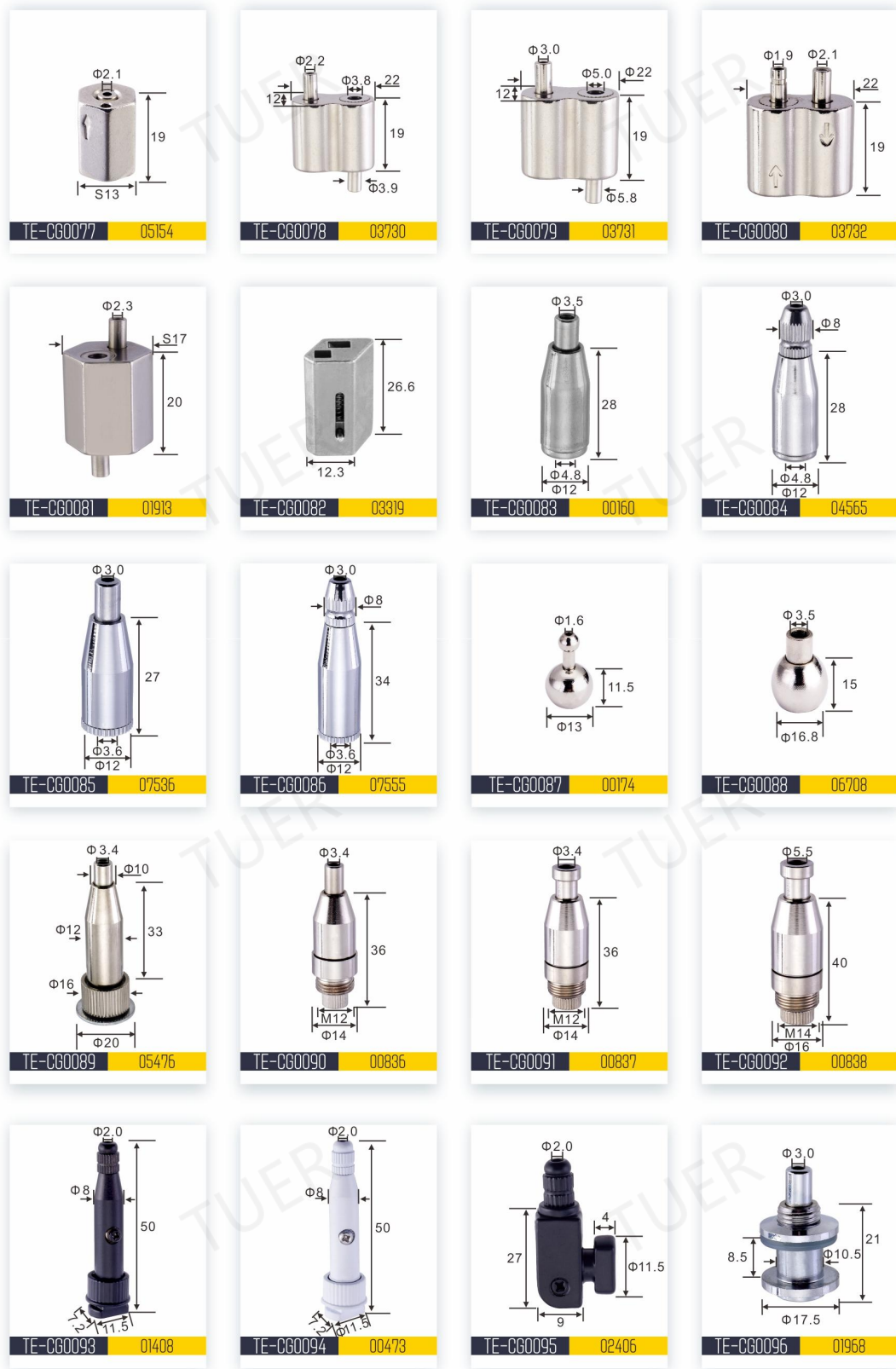

CABLE GRIPPER

锁线器

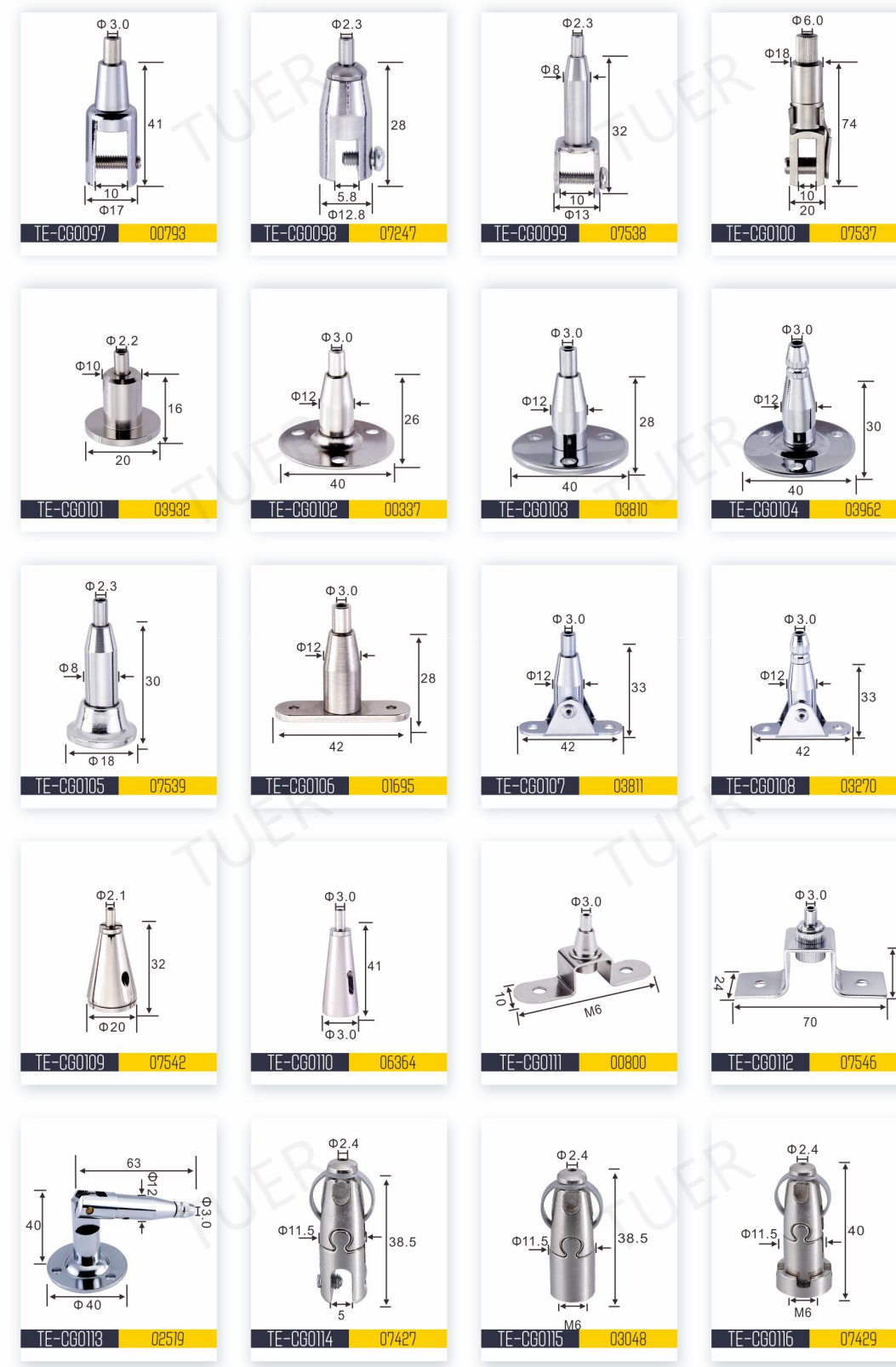

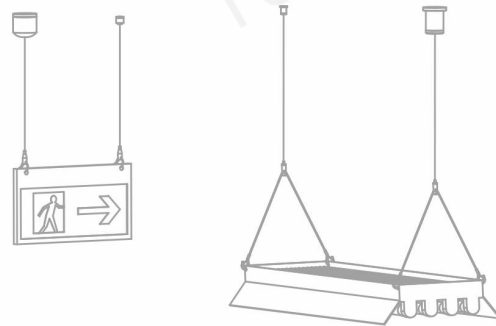

CEILING ATTACHMENT

天花件

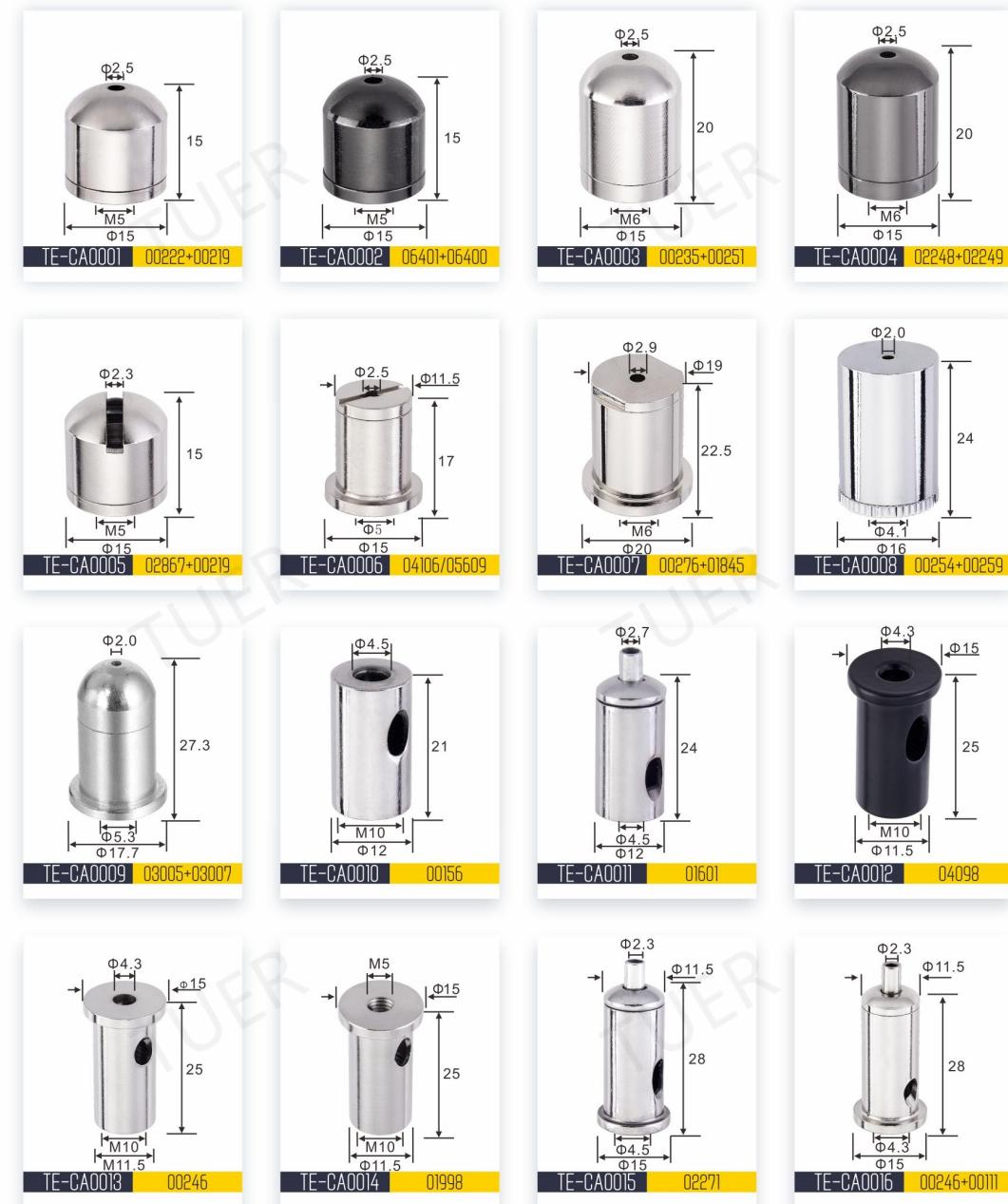

CEILING ATTACHMENT

天花件



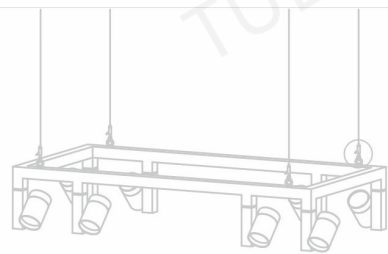

HANGER ADAPTORS ATTACHMENT

吊件/连接件

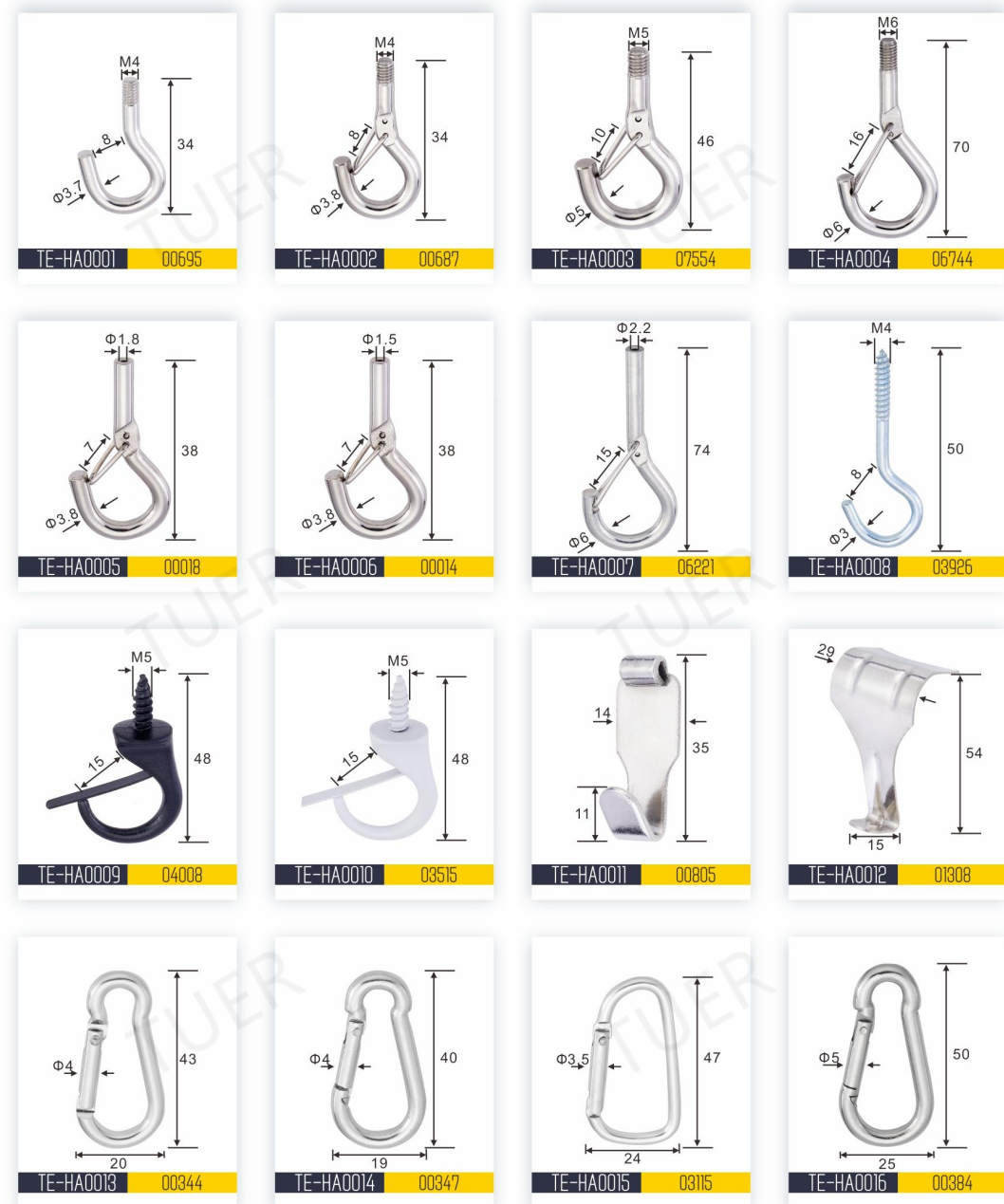

HANGER ADAPTORS ATTACHMENT

吊件/连接件

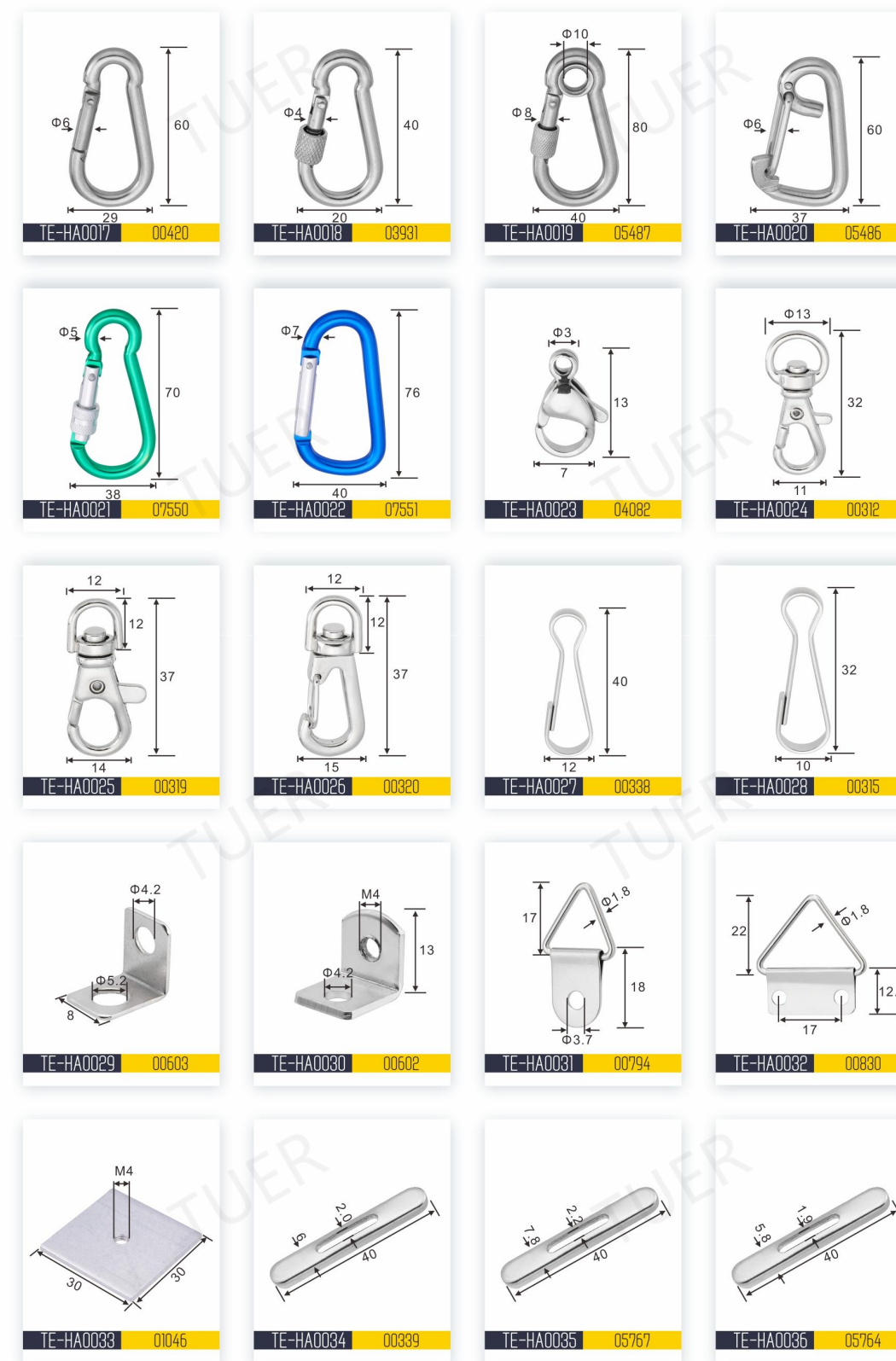



HANGER ADAPTORS ATTACHMENT

吊件/连接件

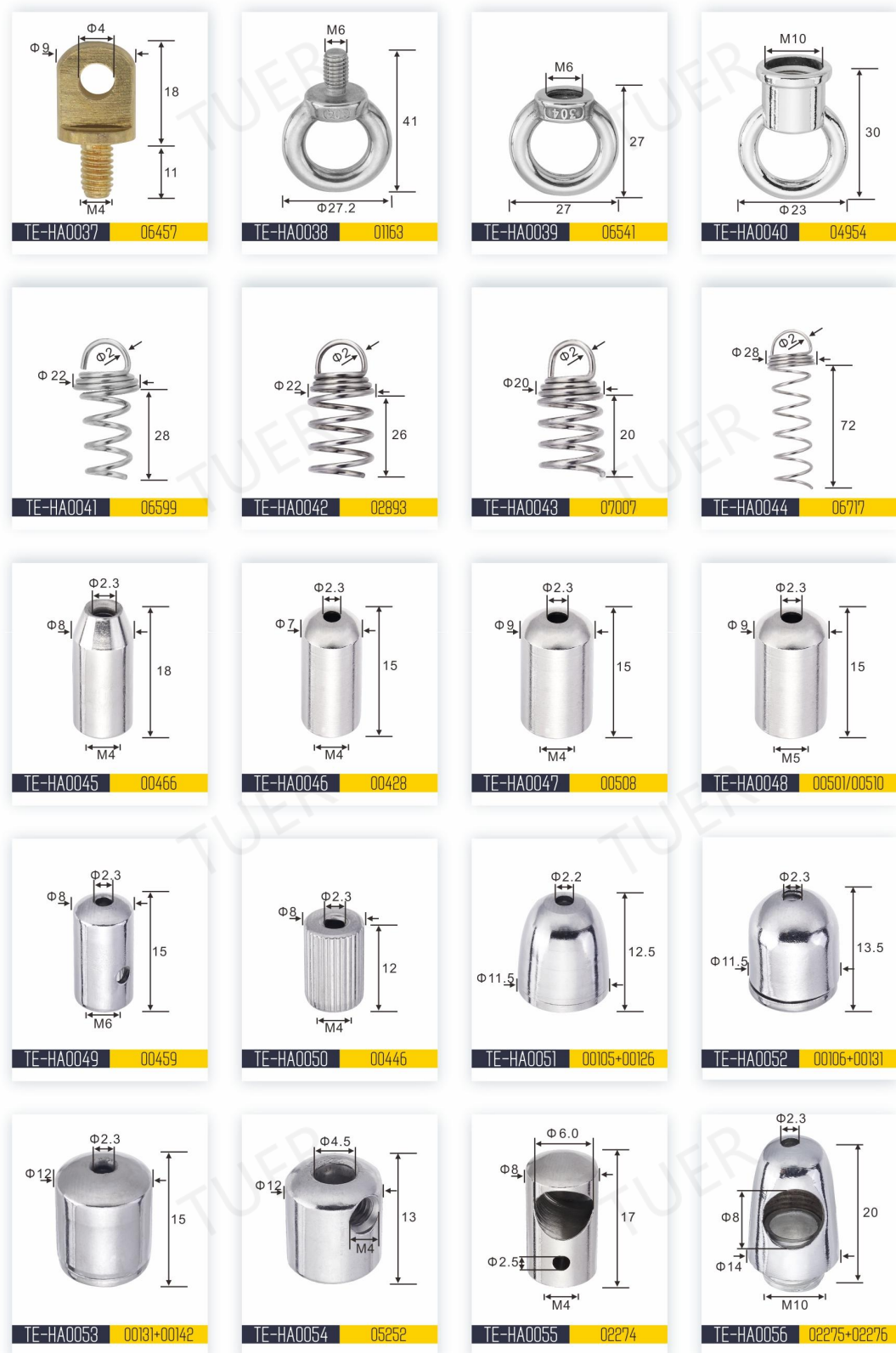

HANGER ADAPTORS ATTACHMENT

吊件/连接件

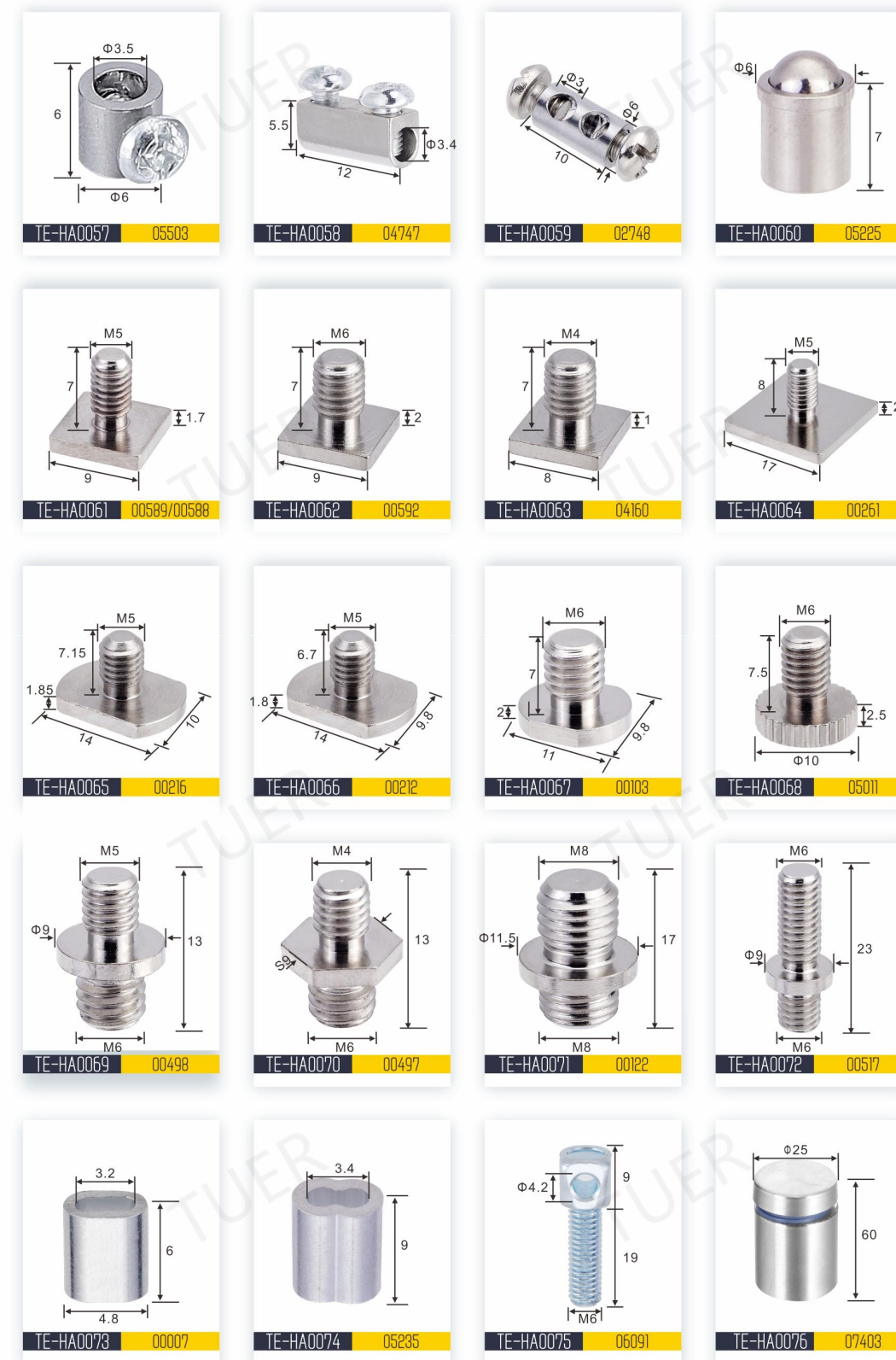



HANGER ADAPTORS ATTACHMENT

吊件/连接件

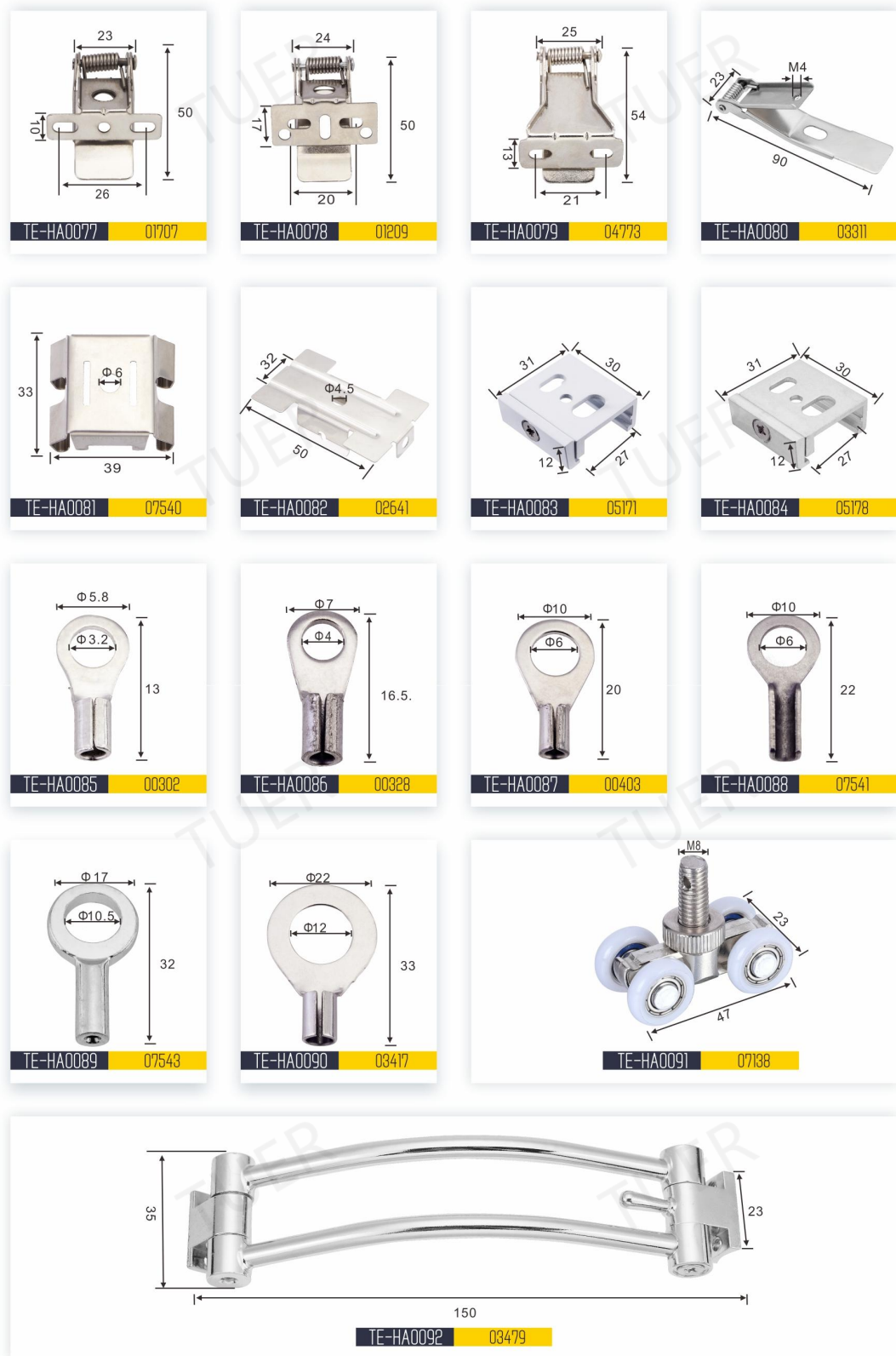

HANGER ADAPTORS ATTACHMENT

吊件/连接件



COIL SPRING LANYARD JUMP ROPES

工具绳子/运动跳绳

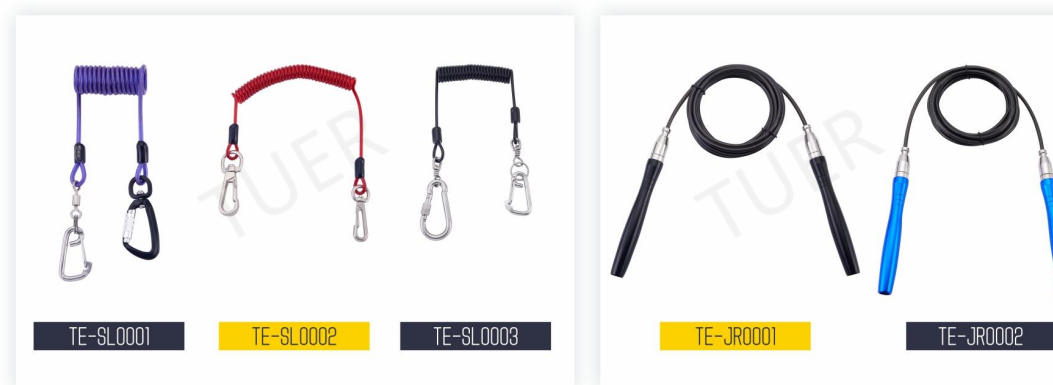



SUSPENSION KITS

吊线组合

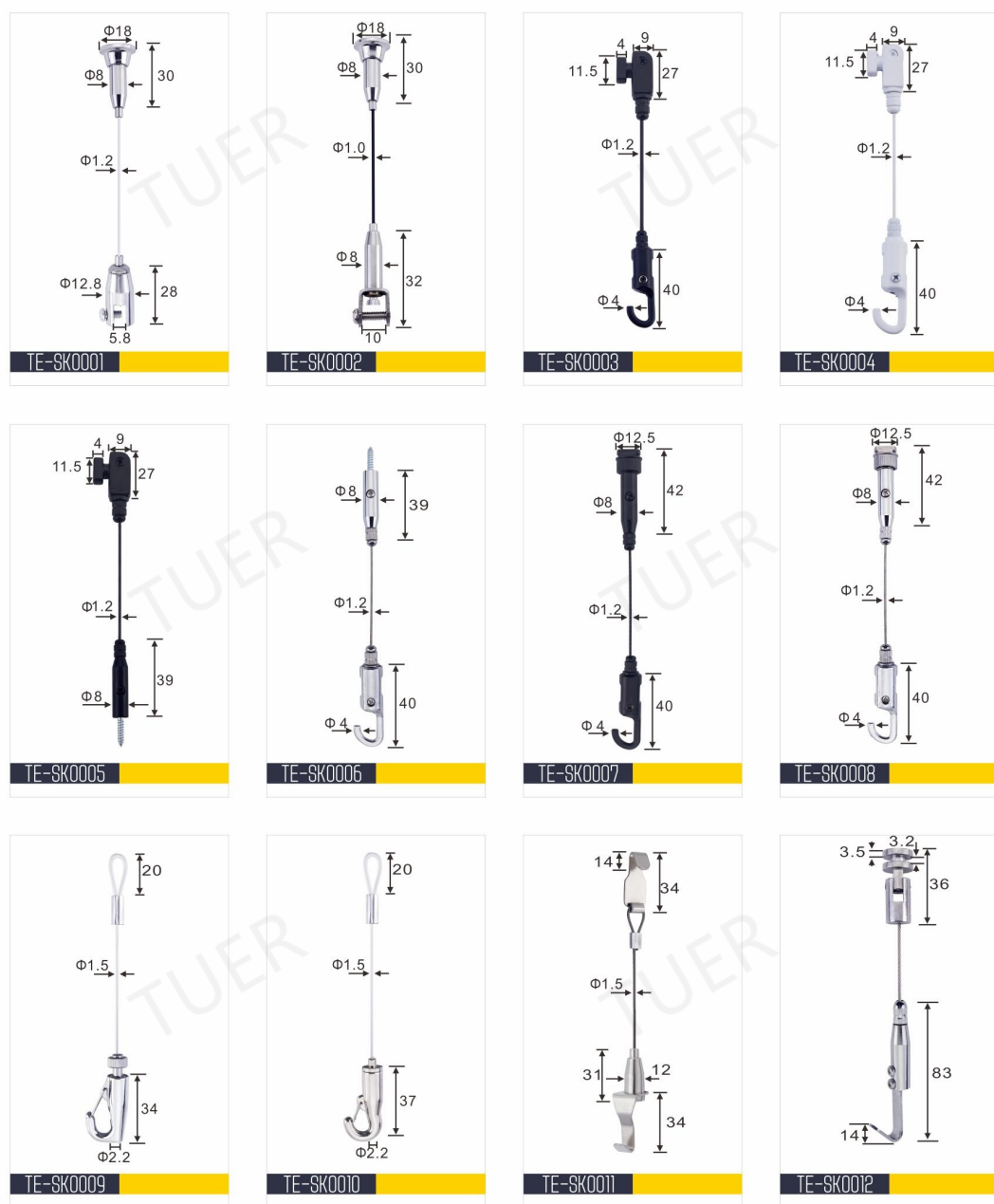

SUSPENSION KITS

吊线组合





SUSPENSION KITS

吊线组合

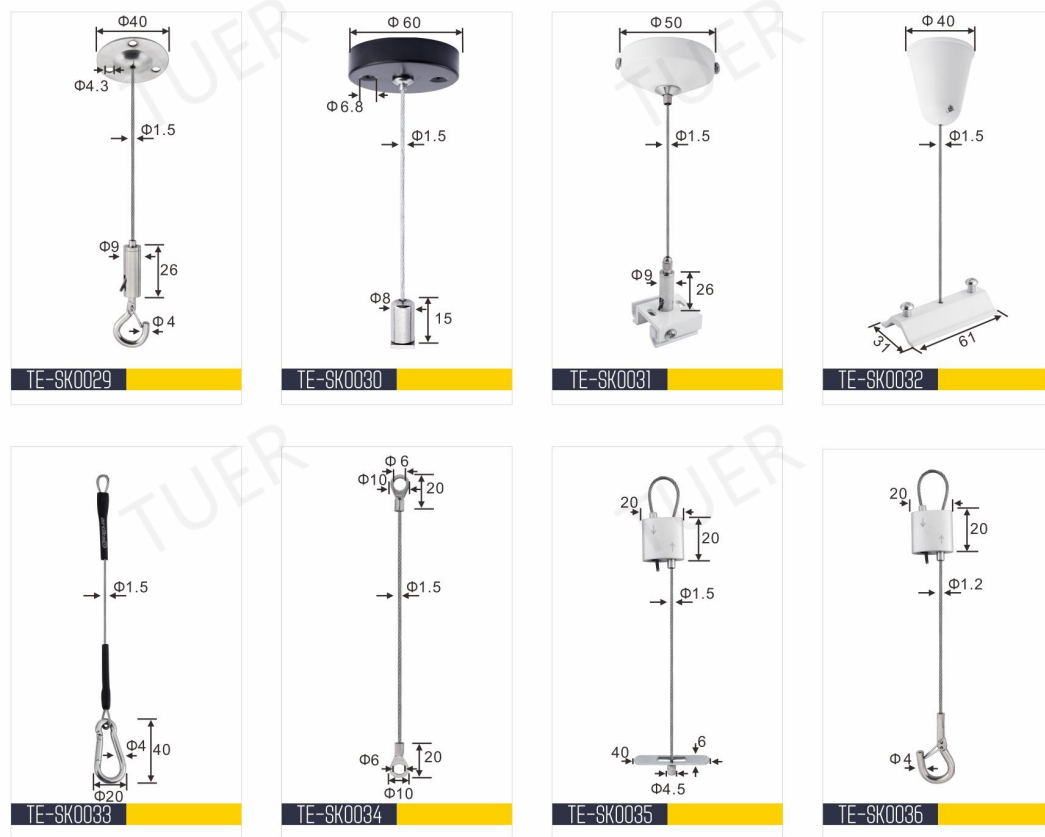

Y-SHAPED SUSPENSION KITS

Y型吊线组合

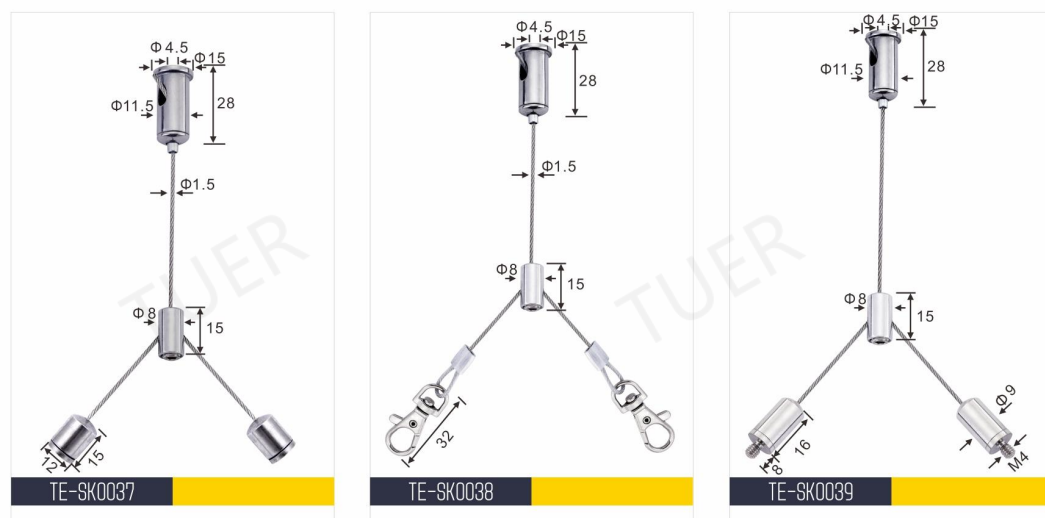

Y-SHAPED SUSPENSION KITS

Y型吊线组合

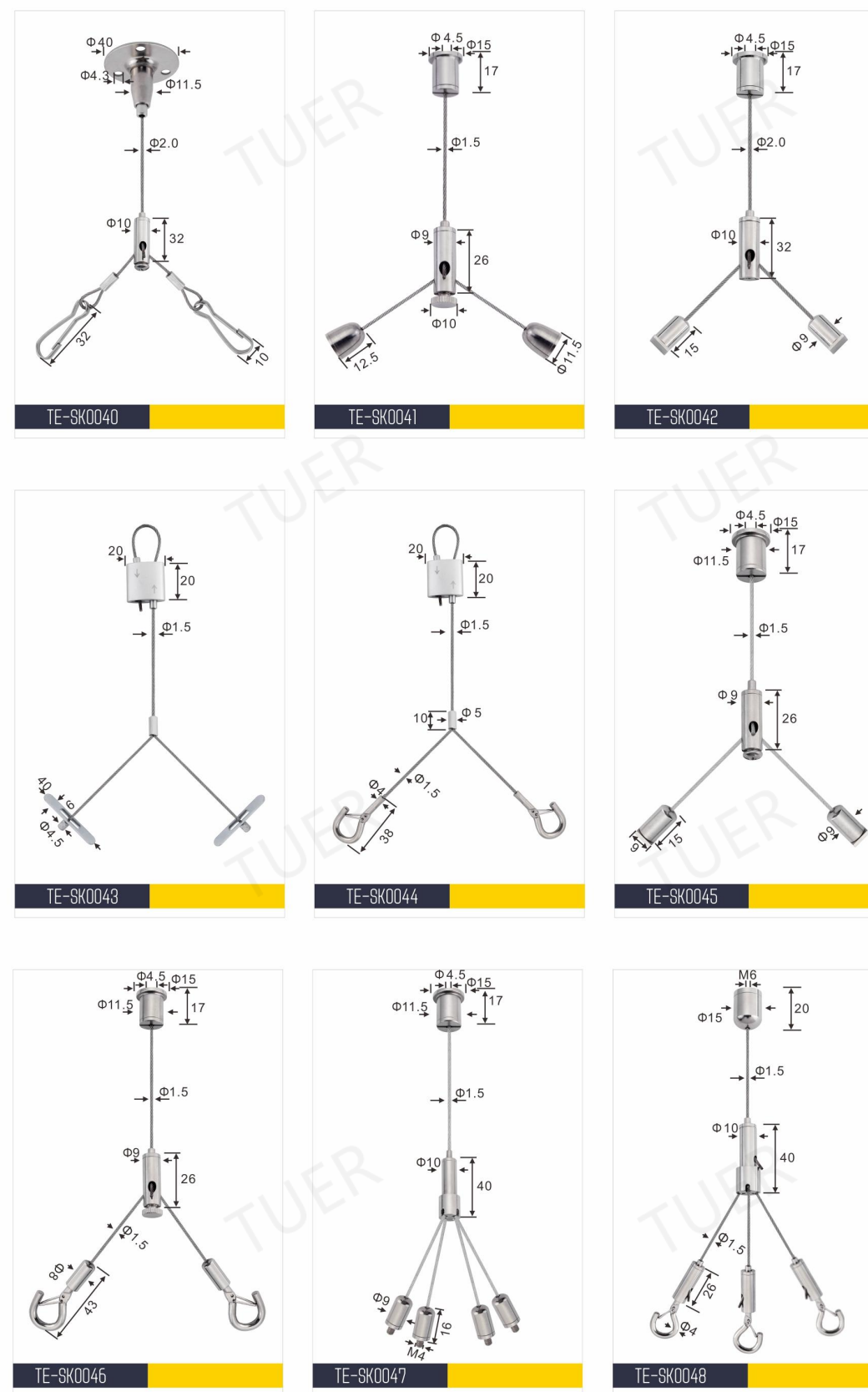



SUSPENSION KITS

吊线组合



MACHINE PARTS

五金车件

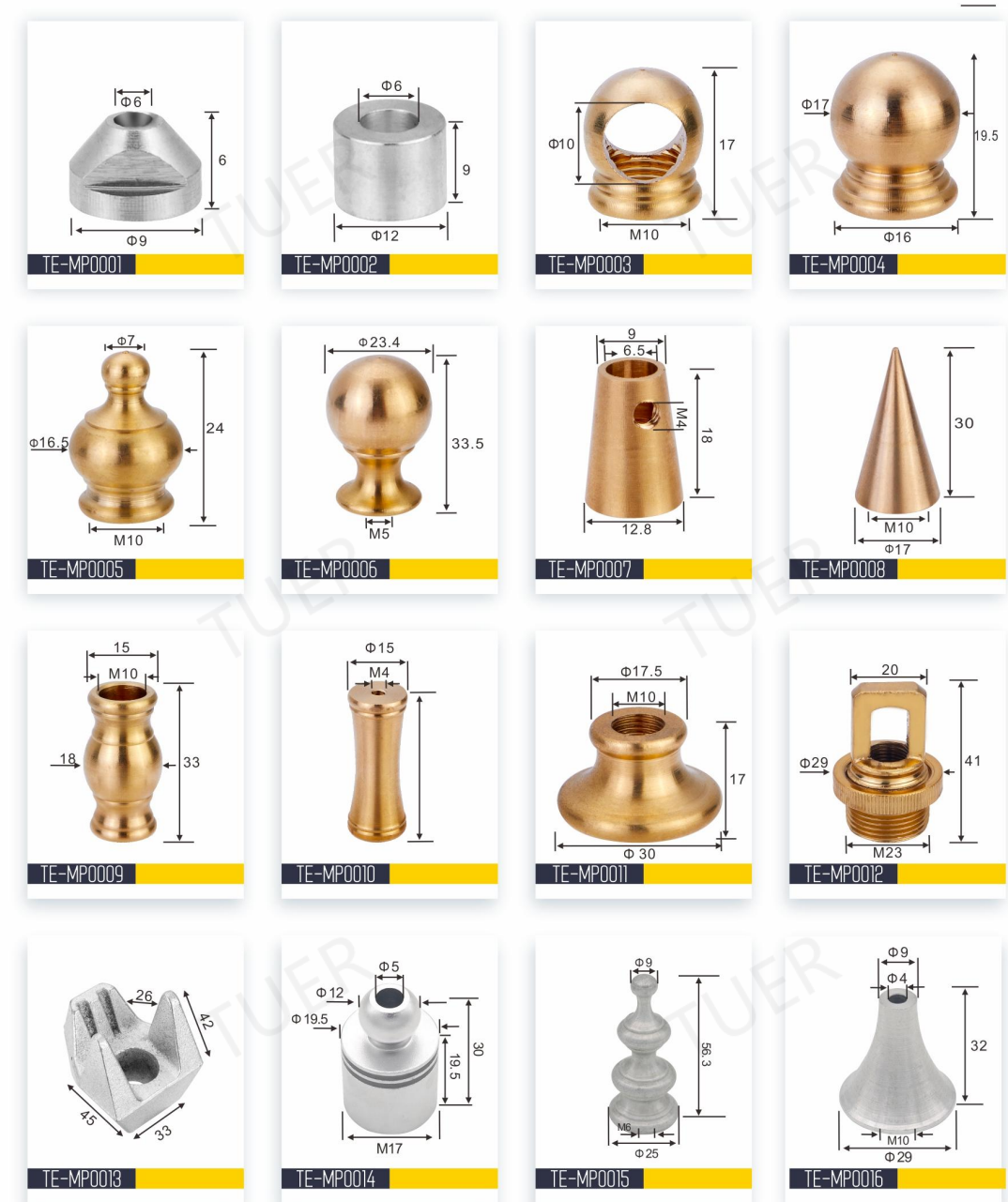



SWIVEL JOINT

万向头



SWIVEL JOINT

万向头





ELECTRIC WIRE

电线

Line NO.	Item NO.	Description	Material (ID/OD)	Color	Packaging	Remarks
1	2X0. 3mm ²	2X0. 3mm ² +wire rope round	<input type="checkbox"/> PVC/PVC <input type="checkbox"/> Teflon/PVC <input type="checkbox"/> Teflon/Teflon	Transparent	100M/Roll	300V/300V, 70° C
2	3X0. 3mm ²	3X0. 3mm ² +wire rope round		Transparent	100M/Roll	300V/300V, 70° C
3	2X0. 5mm ²	2X0. 5mm ² +wire rope round	<input type="checkbox"/> PVC/PVC <input type="checkbox"/> Teflon/PVC <input type="checkbox"/> Teflon/Teflon	Transparent	100M/Roll	300V/300V, 70° C
4	3X0. 5mm ²	3X0. 5mm ² +wire rope round		Transparent	100M/Roll	300V/300V, 70° C
5	4X0. 5mm ²	4X0. 5mm ² +wire rope round		Transparent	100M/Roll	300V/300V, 70° C
6	5X0. 5mm ²	5X0. 5mm ² +wire rope round		Transparent	100M/Roll	300V/300V, 70° C
7	2X0. 75mm ²	2X0. 75mm ² +wire rope round	<input type="checkbox"/> PVC/PVC <input type="checkbox"/> Teflon/PVC <input type="checkbox"/> Teflon/Teflon	Transparent	100M/Roll	300V/300V, 70° C
8	3X0. 75mm ²	3X0. 75mm ² +wire rope round		Transparent	100M/Roll	300V/300V, 70° C
9	4X0. 75mm ²	4X0. 75mm ² +wire rope round		Transparent	100M/Roll	300V/300V, 70° C
10	5X0. 75mm ²	5X0. 75mm ² +wire rope round		Transparent	100M/Roll	300V/300V, 70° C

ELECTRIC WIRE

电线

Line NO.	Item NO.	Description	Material (ID/OD)	Color	Packaging	Remarks
1	1X0. 5mm ²	1X0. 5mm ² round +Wovenmesh round Diameter: 2. 4mm	<input type="checkbox"/> Teflon	Transparent	500M/Roll	300V/300V, 70° C
2	1X0. 5mm ²	1X0. 5mm ² round +Wovenmesh round Diameter: 2. 4mm		Black	500M/Roll	300V/300V, 70° C
3	1X0. 3mm ²	1X0. 3mm ² round	<input type="checkbox"/> PVC <input type="checkbox"/> Teflon	Transparent	200M/Roll	300V/300V, 70° C
4	2X0. 3mm ²	2X0. 3mm ² round	<input type="checkbox"/> PVC/PVC <input type="checkbox"/> Teflon/PVC <input type="checkbox"/> Teflon/Teflon	Transparent	100M/Roll	300V/300V, 70° C
5	3X0. 3mm ²	3X0. 3mm ² round		Transparent	100M/Roll	300V/300V, 70° C
6	1X0. 5mm ²	1X0. 5mm ² round	<input type="checkbox"/> PVC <input type="checkbox"/> Teflon	Transparent	200M/Roll	300V/300V, 70° C
7	2X0. 5mm ²	2X0. 5mm ² round	<input type="checkbox"/> PVC/PVC <input type="checkbox"/> Teflon/PVC <input type="checkbox"/> Teflon/Teflon	Transparent	100M/Roll	300V/300V, 70° C
8	3X0. 5mm ²	3X0. 5mm ² round		Transparent	100M/Roll	300V/300V, 70° C
9	4X0. 5mm ²	4X0. 5mm ² round		Transparent	100M/Roll	300V/300V, 70° C
10	5X0. 5mm ²	5X0. 5mm ² round		Transparent	100M/Roll	300V/300V, 70° C
11	2X0. 75mm ²	2X0. 75mm ² round	<input type="checkbox"/> PVC/PVC <input type="checkbox"/> Teflon/PVC <input type="checkbox"/> Teflon/Teflon	Transparent	100M/Roll	300V/300V, 70° C
12	3X0. 75mm ²	3X0. 75mm ² round		Transparent	100M/Roll	300V/300V, 70° C
13	4X0. 75mm ²	4X0. 75mm ² round		Transparent	100M/Roll	300V/300V, 70° C
14	5X0. 75mm ²	5X0. 75mm ² round		Transparent	100M/Roll	300V/300V, 70° C
15	2X0. 3mm ²	2X0. 3mm ² FLAT	<input type="checkbox"/> PVC/PVC <input type="checkbox"/> Teflon/PVC <input type="checkbox"/> Teflon/Teflon	Transparent	100M/Roll	300V/300V, 70° C
16	2X0. 5mm ²	2X0. 5mm ² FLAT		Transparent	100M/Roll	300V/300V, 70° C
17	2X0. 75mm ²	2X0. 75mm ² FLAT		Transparent	100M/Roll	300V/300V, 70° C



WIRE ROPE

钢丝绳

WIRE ROPE CONSTRUCTION & CROSS SECTIONS

钢丝绳结构和横截面



7*7



7*7-PVC Coated



1*19



Construction	Material	Diameter(mm)	break load (kg)	Safe load (5:1)
产品结构	材质	规格线径	破断拉力(kg)	安全承重(5:1)
<p>7*7</p>	<input type="checkbox"/> Galvanized <input type="checkbox"/> 201 stainless steel <input type="checkbox"/> 304 stainless steel	0.8mm	41.6	8.3
		1.0mm	65.0	13.0
		1.2mm	93.6	18.7
		1.5mm	146.3	29.3
		1.8mm	210.7	42.1
		2.0mm	260.1	52.0
		2.5mm	406.4	81.3
		3.0mm	585.2	117.0
		4.0mm	1040.3	208.1
<p>7*7-PVC Coated</p>	<input type="checkbox"/> Galvanized <input type="checkbox"/> 201 stainless steel <input type="checkbox"/> 304 stainless steel	0.8mm	16.3	3.3
		1.0mm	41.6	8.3
		1.2mm	65.0	13.0
		1.5mm	93.6	18.7
		2.0mm	146.3	29.3
<p>1*19</p>	<input type="checkbox"/> Galvanized <input type="checkbox"/> 201 stainless steel <input type="checkbox"/> 304 stainless steel	0.8mm	63.0	12.6
		1.0mm	96.9	19.4
		1.5mm	229.6	45.9
		2.0mm	389.8	78.0
		2.5mm	569.4	113.9
		3.0mm	819.4	163.9
		4.0mm	1418.0	283.6
		5.0mm	2142.0	428.4
6.0mm	3102.0	620.4		

DIE-CASTING END STOPPER

钢丝绳钎头规格表

线径 (Wire diameter) : 0.8 尺寸 (size) : 4*4		线径 (Wire diameter) : 1.5 尺寸 (size) : 4*5圆头	
线径 (Wire diameter) : 1.0 尺寸 (size) : 4*5圆头		线径 (Wire diameter) : 1.5 尺寸 (size) : 4MM圆球	
线径 (Wire diameter) : 1.2 尺寸 (size) : 3.8*4.5		线径 (Wire diameter) : 1.5 尺寸 (size) : 5.7*9倒圆头	
线径 (Wire diameter) : 1.2 尺寸 (size) : 3*5圆头		线径 (Wire diameter) : 1.5 尺寸 (size) : 5*6T头	
线径 (Wire diameter) : 1.2 尺寸 (size) : 4.0端子		线径 (Wire diameter) : 1.5 尺寸 (size) : 5MM圆球	
线径 (Wire diameter) : 1.2 尺寸 (size) : 4*5		线径 (Wire diameter) : 1.5 尺寸 (size) : 6MM圆球	
线径 (Wire diameter) : 1.2 尺寸 (size) : 4*5圆头		线径 (Wire diameter) : 1.5 尺寸 (size) : 6*6横头	
线径 (Wire diameter) : 1.2 尺寸 (size) : 4MM圆球		线径 (Wire diameter) : 1.5 尺寸 (size) : 6*7	
线径 (Wire diameter) : 1.2 尺寸 (size) : 5*6横头		线径 (Wire diameter) : 1.5 尺寸 (size) : 6*7横头	
线径 (Wire diameter) : 1.2 尺寸 (size) : 6.8*8T头		线径 (Wire diameter) : 1.5 尺寸 (size) : 9.5*8T头	
线径 (Wire diameter) : 1.5 尺寸 (size) : 2.8*5圆头		线径 (Wire diameter) : 1.5 尺寸 (size) : 8*3.5	
线径 (Wire diameter) : 1.5 尺寸 (size) : 3*5圆头		线径 (Wire diameter) : 1.8 尺寸 (size) : 4.5*6	
线径 (Wire diameter) : 1.5 尺寸 (size) : 4.5*6		线径 (Wire diameter) : 2.0 尺寸 (size) : 4*5	
线径 (Wire diameter) : 1.5 尺寸 (size) : 4*4		线径 (Wire diameter) : 2.0 尺寸 (size) : 4*5圆头	
线径 (Wire diameter) : 1.5 尺寸 (size) : 4*5		线径 (Wire diameter) : 2.0 尺寸 (size) : 5.5MM圆球	